

M12 FEMALE 90° SHIELDED

PVC 5X0.34 shielded GRAY, 45m

Female 90°

M12, 5-pole

shielded

with cable sleeves

Plastic housings with good resistance against chemicals and oils.

The resistance to aggressive media should be individually tested for your application. Further details on request.

Further cable lengths on request.

Illustration

stay connected

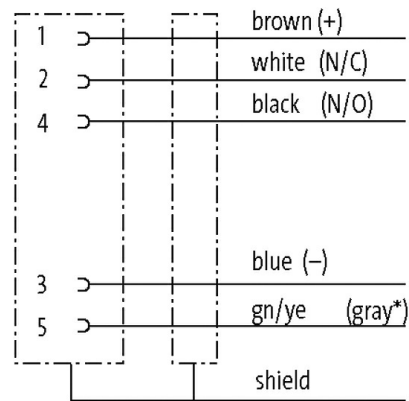
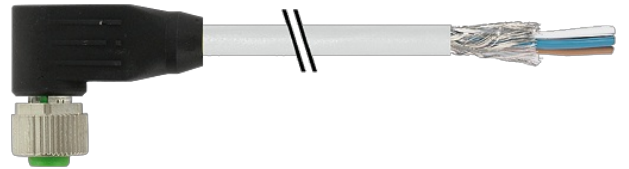

(* for cable type 203, 603, 243, 643)

Female



Product may differ from Image

Approvals

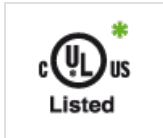

cCSAus

* only for products with UL/CSA approved cable

EAC

Form

Form 13281

Cables

Cable number	348
No./diameter of wires	5 x 0.34 mm ²
Wire isolation	PVC (br, wh, bl, bk, gnye)
Jacket Color	gray
Material (jacket)	PVC
Outer Ø	5.9 mm ±5%
Bend radius (fixed)	10x outer Ø
Bend radius (moving)	15x outer Ø
Temperature range (fixed)	-30...+80 °C
Temperature range (mobile)	-5...+70 °C
Shield	yes
Color (jacket)	gray
Approval (cable)	CE conform

Technical Data

Operating voltage	max. 60 V AC/DC
Operating voltage (only UL listed)	30 V AC/DC
Rated surge voltage	1.5 kV
Operating current per contact	max. 4 A
No. of poles	5
Material group	IEC 60664-1, category I
Coding	A-coded
LED display	no
Locking of ports	Screw thread (M12x1 mm) recommended torque 0.6 Nm, self-securing
Compression gland	M12 (SW13)
Protection	IP65, IP66K, IP67 inserted and tightened (EN 60529)
Locking material	Zinc die casting, matte nickel plated
Material	PUR
suitable for corrugated tube (internal Ø)	without

General data

Standards	DIN EN 61076-2-101 (M12)
Mounting method	inserted, tightened
Material (contact)	Copper alloy
Material (contact surface)	Au
Material (gasket)	FKM
Pollution Degree	3
Stripping length (jacket)	20 mm
Temperature range	-25...+85 °C, depending on cable quality

Commercial data

country of origin	CZ
customs tariff number	85444290
EAN	4048879337236
eClass	27279218

Packaging unit

1